



N A M E Š T A J • [www.matis.rs](http://www.matis.rs)  
Senjak bb\*32250 Ivanjica\*Srbija

Tel:032 651 159\* Fax:032 651 060

[office@matic.rs](mailto:office@matic.rs)\*[veleprodaja@matic.rs](mailto:veleprodaja@matic.rs)\*[www.matis.rs](http://www.matis.rs)

## DEČIJA SOBA "KINDER" FIOKA KREVETA

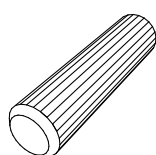
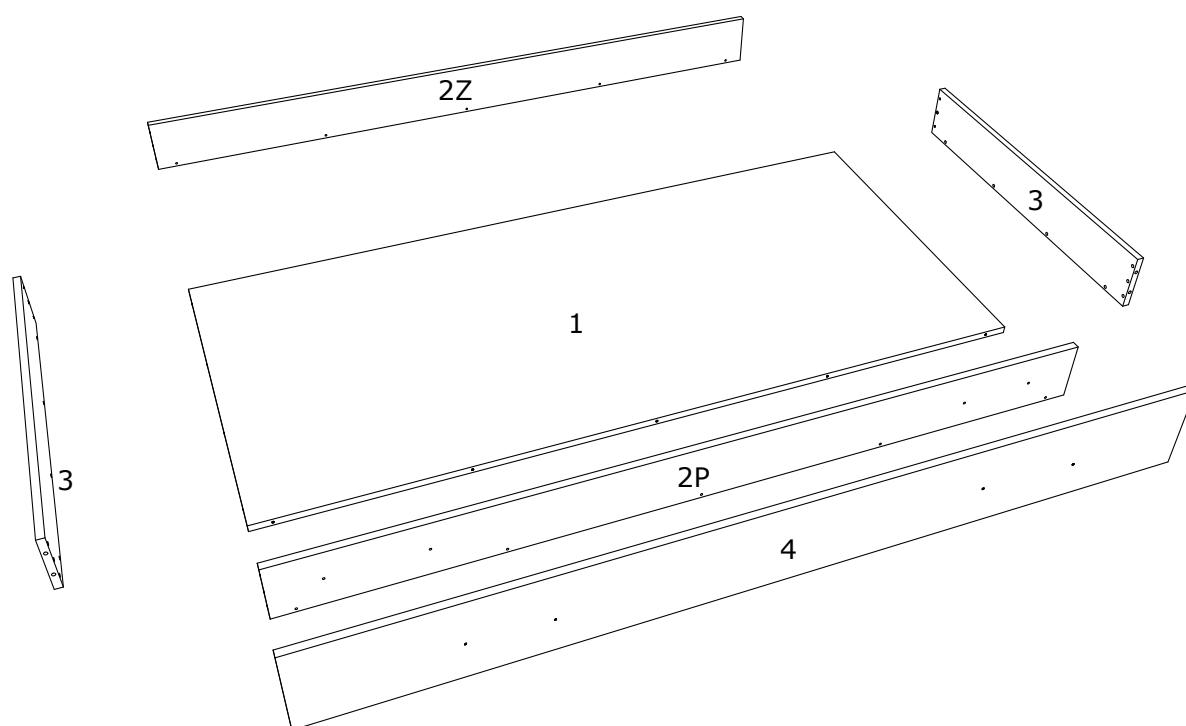
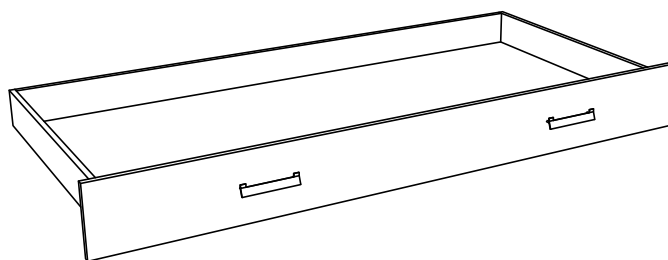

A

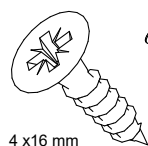

4 x 16 mm

E2



M4x40mm

K



D16

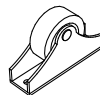

T1



R1

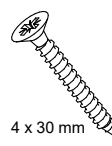

4 x 30 mm

E4

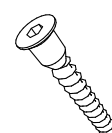

J

